

KEYWAY CUTTING ATTACHMENT FOR LATHE

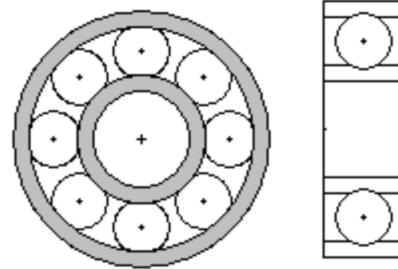

6201 12 x 32 x 10

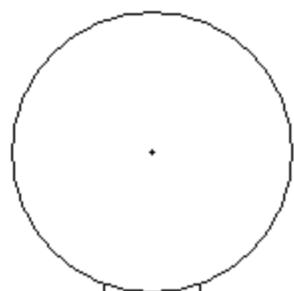
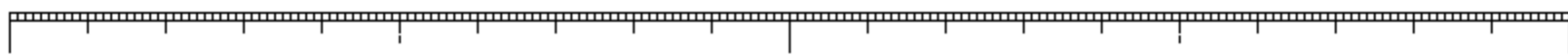
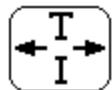

41.25 mm

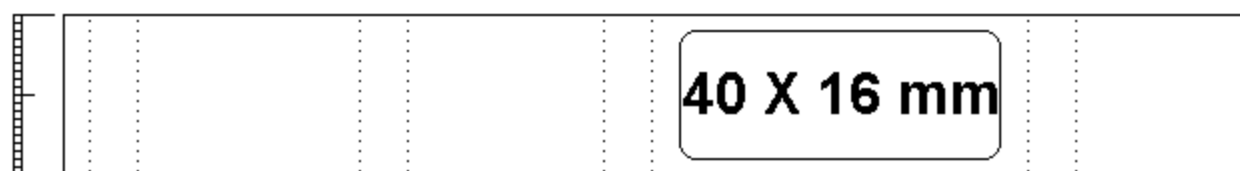
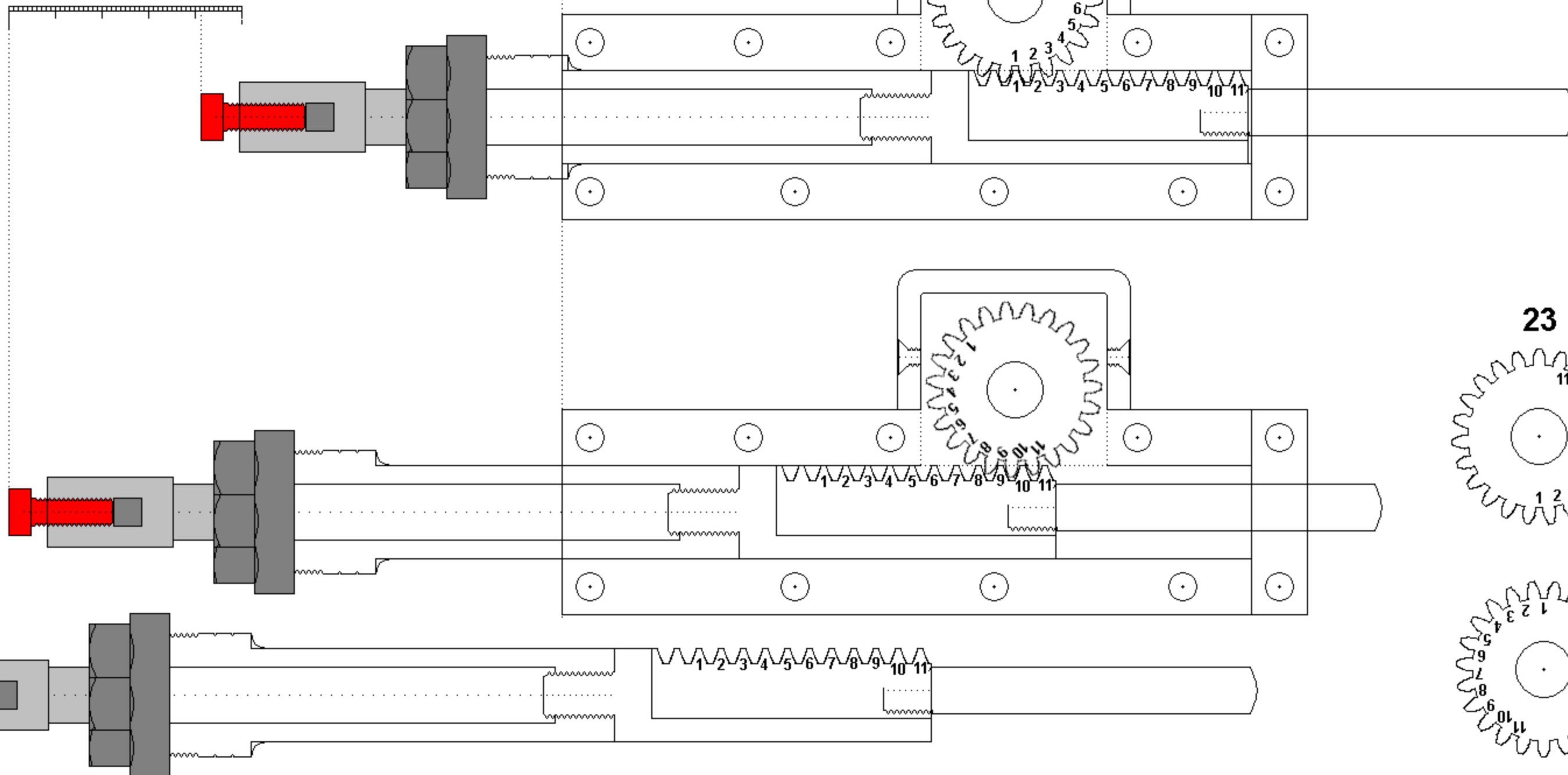

40 X 16 mm



40 X 16 mm

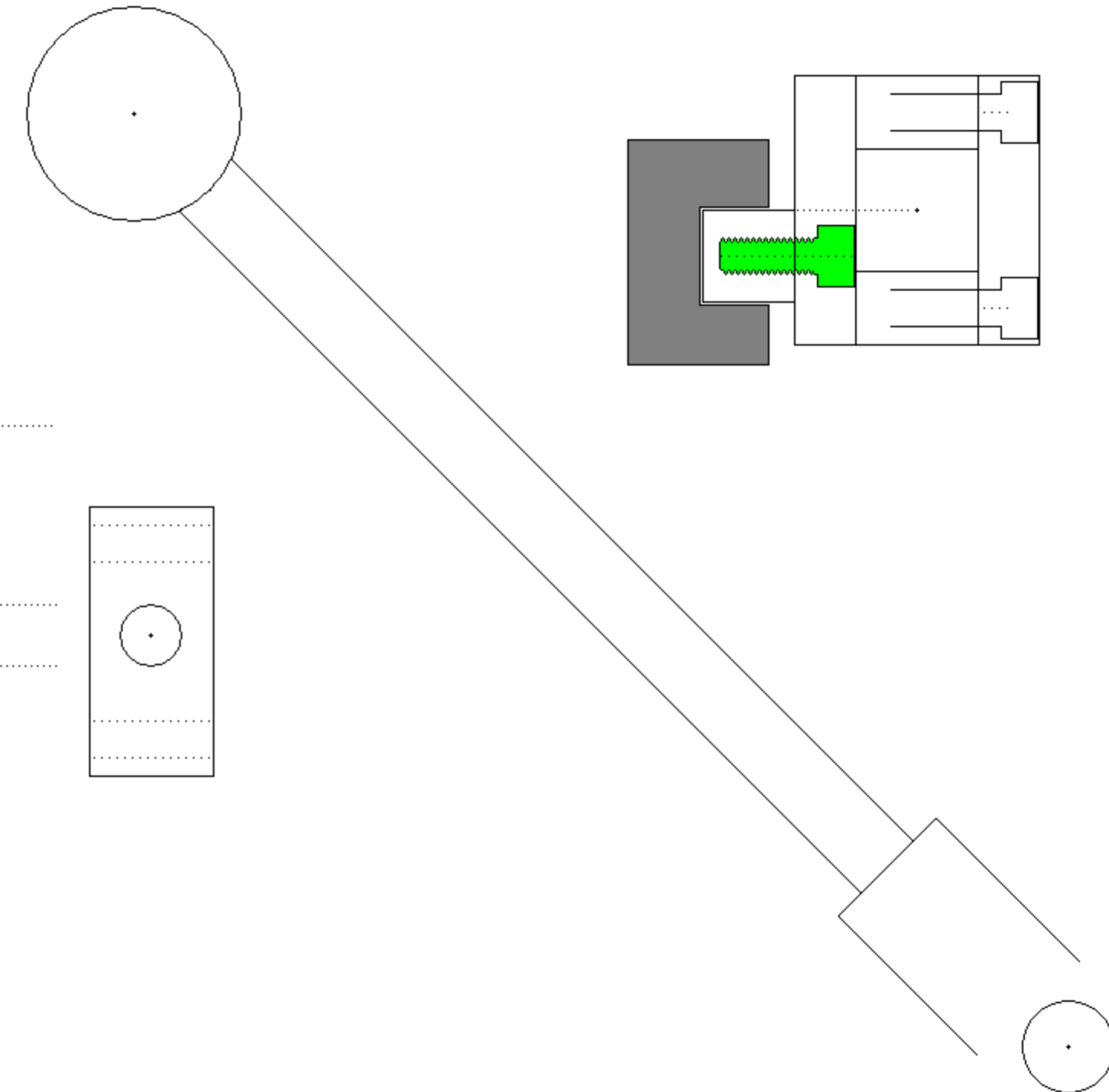
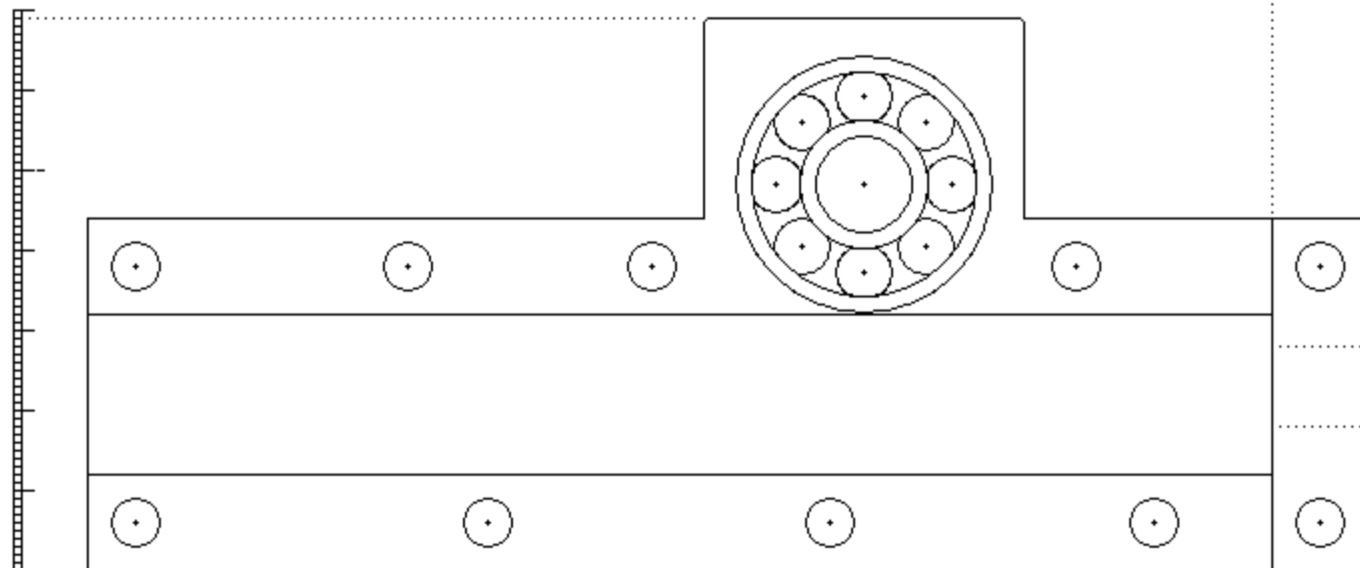

23

